

E-Anschluß

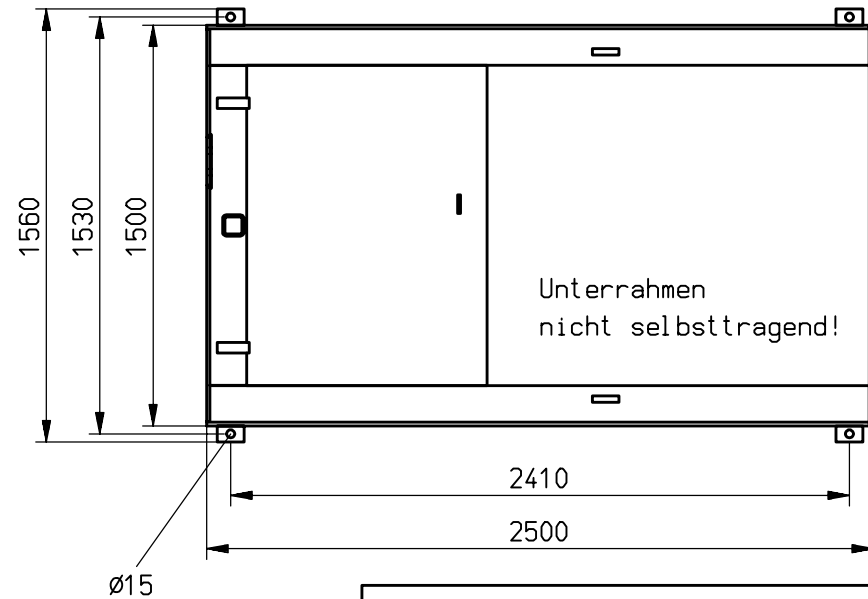
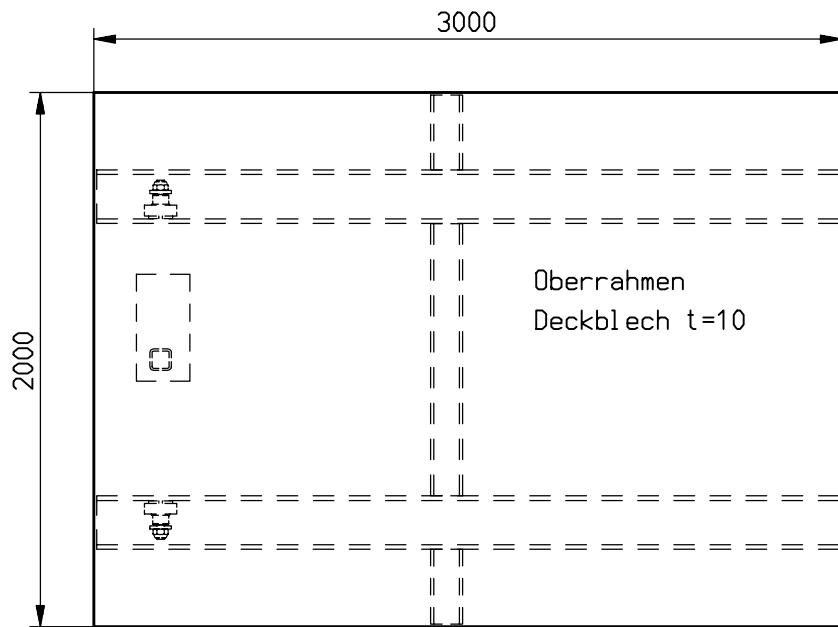
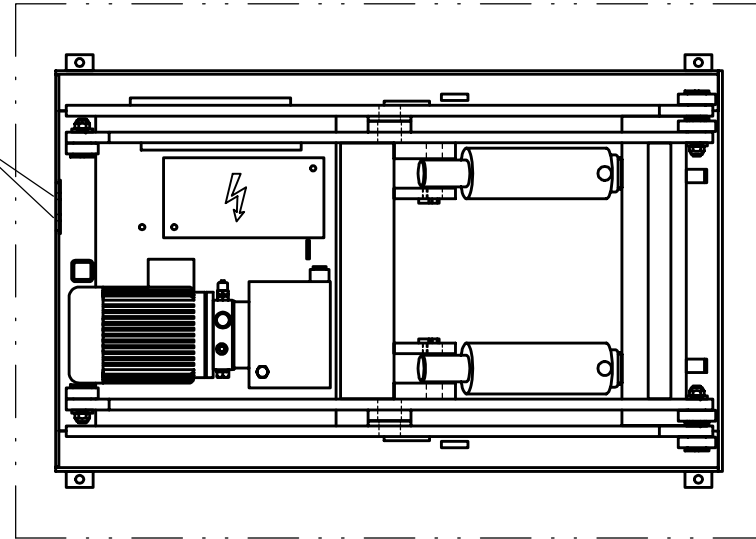

Maßblatt ELS 10-16-19